

Single 10" Jumbo Tissue Dispenser

Product Overview

The Single 10" Jumbo Roll Tissue Dispenser offers a simplistic design with modern appeal. The cover and back are hinged together, making the unit one piece. A front window allows for easy view of paper supply.



Product Features:

- Design offers simplistic & modern appeal
- Window allows for easy view of paper supply
- Cover & back are hinged together (making it one piece)
- Holds up to a 10" roll with a 2-1/4" core
- Works with cores as small as 1-3/4"

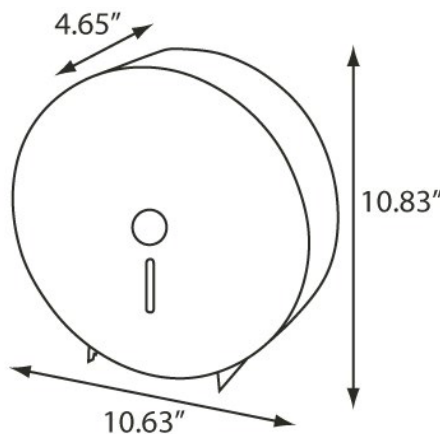

More information and images available online.

MODEL #	COLOR	
RD0346-09	BRUSHED STAINLESS	09
RD0346-17	WHITE	17

Specifications:

Dimensions (in)	10.63"w x 10.63"h x 4.65"d
Weight (lb)	2.80 lb
Key Type	13
Capacity	10" Jumbo Roll Tissue
Case Pack	6 (2.75 ³)
Pallet Qty	180 units